

2 Amps, 600 Volts N-CHANNEL MOSFET

2N60

FEATURES

- $R_{DS(on)}=3.8\Omega@V_{GS}=10V$.
- Ultra Low gate charge (typical 9.0nC)  Lead-free
- Low reverse transfer capacitance ($C_{rss} = \text{typical } 5.0 \text{ pF}$)
- Fast switching capability
- Avalanche energy specified
- Improved dv/dt capability, high ruggedness

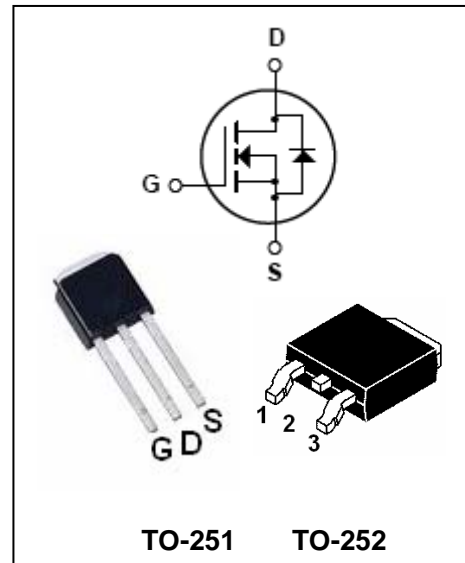

MAXIMUM RATING operating temperature range applies unless otherwise specified

Symbol	Parameter	Value	Units
V_{DSS}	Drain-Source voltage	600	V
I_D	Drain current continuous	$(T_C=25^\circ\text{C})$	2.0
		$(T_C=100^\circ\text{C})$	1.26
I_{DP}	Drain current Pulsed (Note2)	8.0	A
V_{GSS}	Gate -Source voltage	± 30	V
I_{AR}	Avalanche Current (Note2)	2.0	A
E_{AR}	Avalanche Energy Repetitive(Note 2)	4.5	mJ
E_{AS}	Avalanche Energy Single Pulse(Note 3)	140	mJ
dv/dt	Peak Diode Recovery dv/dt (Note4)	4.5	V/ns
P_D	Power Dissipation	$(T_C=25^\circ\text{C})$	45
		Derate above 25°C	0.36
T_J	Junction Temperature	+150	$^\circ\text{C}$
T_{STG}	Storage Temperature	-55 ~ +150	$^\circ\text{C}$
θ_{JA}	Thermal Resistance Junction-Ambient	112	$^\circ\text{C/W}$
θ_{Jc}	Thermal Resistance Junction-Case	12	$^\circ\text{C/W}$



2 Amps, 600 Volts N-CHANNEL MOSFET

2N60

Note:1. Absolute maximum ratings are those values beyond which the device could be permanently damaged.

Absolute maximum ratings are stress ratings only and functional device operation is not implied.

2. Repetitive Rating: Pulse width limited by maximum junction temperature

3. $L=64\text{mH}$, $I_{AS}=2.0\text{A}$, $V_{DD}=50\text{V}$, $R_G=25\ \Omega$, Starting $T_J = 25^\circ\text{C}$

4. $I_{SD} \leq 2.4\text{A}$, $di/dt \leq 200\text{A}/\mu\text{s}$, $V_{DD} \leq BV_{DSS}$, Starting $T_J = 25^\circ\text{C}$

ELECTRICAL CHARACTERISTICS@ $T_a=25^\circ\text{C}$ unless otherwise specified

Parameter	Symbol	Test conditions	MIN	TYP	MAX	UNIT
Drain-Source Breakdown Voltage	BV_{DSS}	$V_{GS}=0\text{V}, I_D=250\mu\text{A}$	600	-	-	V
Breakdown Voltage Temperature Coefficient	$\Delta BV_{DSS}/\Delta T_J$	$I_D=250\mu\text{A}$	-	0.4	-	$\text{V}/^\circ\text{C}$
Zero Gate Voltage Drain Current	I_{DSS}	$V_{DS}=600\text{V}, V_{GS}=0\text{V}$	-	-	10	μA
		$V_{DS}=480\text{V}, T_C=125^\circ\text{C}$	-	-	100	
Gate-body Leakage	I_{GSS}	Forward $V_{DS}=0\text{V}, V_{GS}=30\text{V}$	-	-	100	nA
		Reverse $V_{DS}=0\text{V}, V_{GS}=-30\text{V}$	-	-	-100	
Gate Threshold Voltage	$V_{GS(th)}$	$V_{DS}=V_{GS}, I_D=250\mu\text{A}$	2.0	-	4.0	
Static drain-Source on-resistance	$R_{DS(ON)}$	$V_{GS}=10\text{V}, I_D=1\text{A}$,	-	3.8	5	Ω
Forward transconductance	g_{FS}	$V_{DS}=50\text{V}, I_D=1\text{A}$ (Note1)	-	2.25	-	S
Input Capacitance	C_{iss}	$V_{DS}=25\text{V}, V_{GS}=0\text{V}, f=1.0\text{MHz}$	-	270	350	μF
Output Capacitance	C_{oss}		-	40	50	μF
Reverse Transfer Capacitance	C_{rss}		-	5	7	μF
Turn-On Delay Time	$t_{d(on)}$	$V_{DD}=300\text{V}, I_D=2.4\text{A}, R_G=25\Omega$ (Note1,2)	-	10	30	ns
Turn-On Rise Time	t_R		-	25	60	ns
Turn-Off Delay Time	$t_{d(off)}$		-	20	50	ns
Turn-Off Fall Time	t_f		-	25	60	ns
Total Gate Charge	Q_g	$V_{DS}=480\text{V}, I_D=2.4\text{A}, V_{GS}=10\text{V}$ (Note1,2)	-	9.0	11	nC
Gate-Source Charge	Q_{gs}		-	1.6	-	nC
Gate-Drain Charge	Q_{gd}		-	4.3	-	nC
Maximum Continuous Drain-Source Diode Forward Current	I_{SD}		-	-	2.0	A
Maximum Pulsed Drain-Source Diode Forward Current	I_{SM}		-	-	8.0	A
Drain-Source Recovery Charge	V_{SD}	$V_{GS}=0\text{V}, I_{SD}=2.0\text{A}$	-	-	1.4	V
Reverse Recovery Time	t_{rr}	$V_{GS}=0\text{V}, I_{SD}=2.4\text{A}$, $di_F/dt=100\text{A}/\mu\text{s}$ (Note1)	-	180	-	ns
Reverse Recovery Charge	Q_{rr}		-	0.72	-	μC

Notes:

1. Pulse Test: Pulse Width $\leq 300\mu\text{s}$, Duty Cycle $\leq 2\%$

2. Essentially Independent of Operating Temperature



2 Amps, 600 Volts N-CHANNEL MOSFET

2N60

TYPICAL CHARACTERISTICS @ $T_a=25^\circ\text{C}$ unless otherwise specified

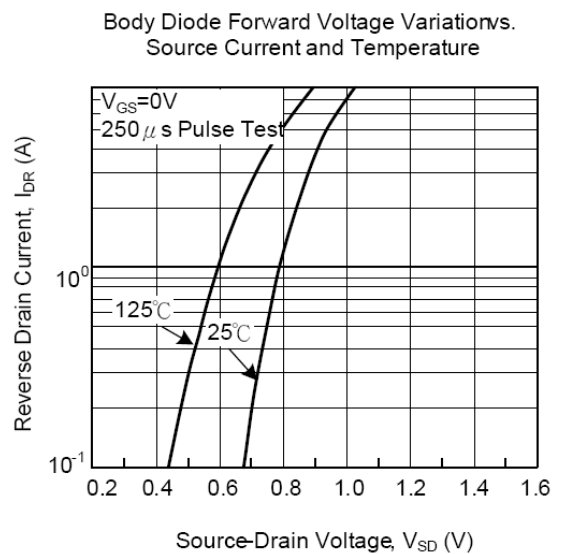
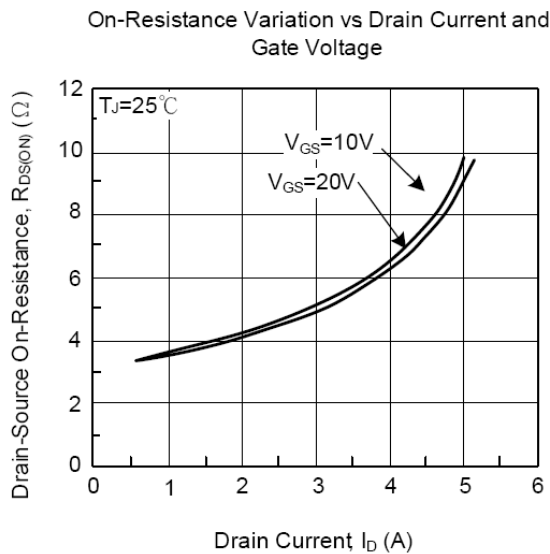
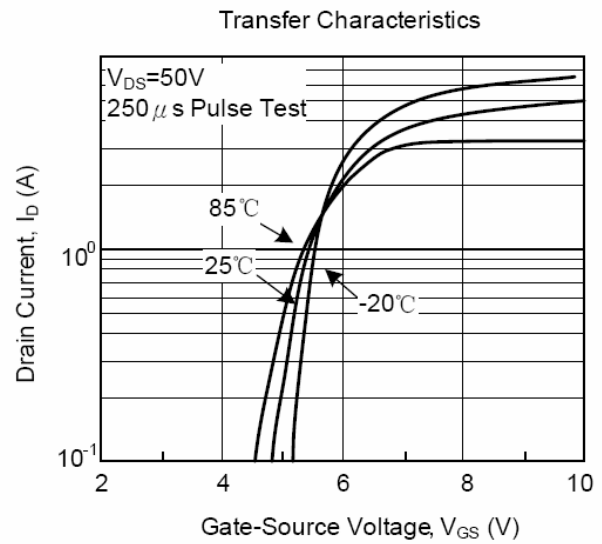
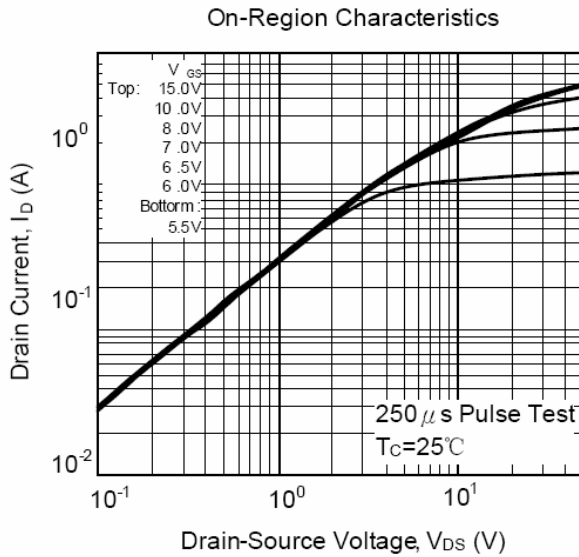



2 Amps, 600 Volts N-CHANNEL MOSFET

2N60

Capacitance vs. Drain-Source Voltage

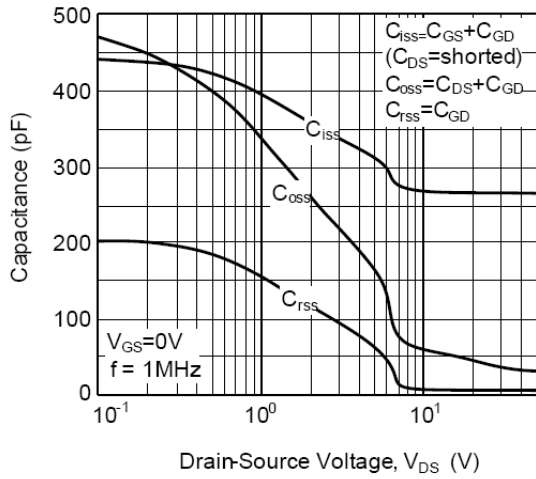

Gate Charge vs. Gate Charge Voltage

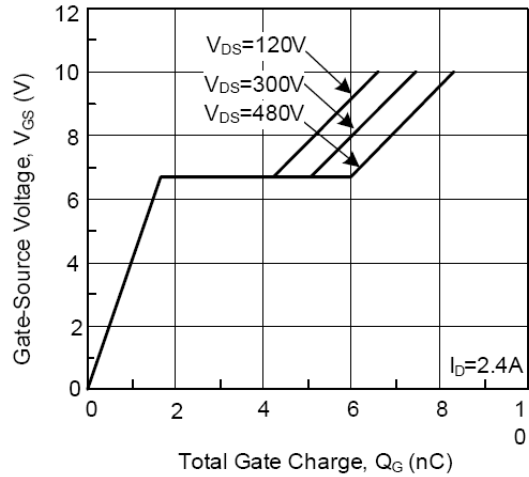

Breakdown Voltage vs Temperature

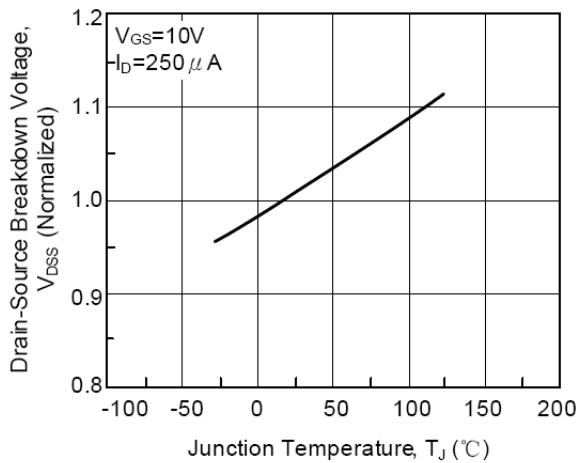

On-Resistance vs. Temperature

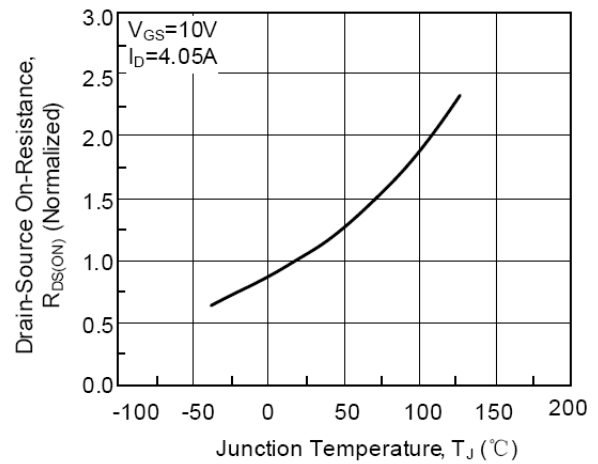



2 Amps, 600 Volts N-CHANNEL MOSFET

2N60

Max. Safe Operating Area

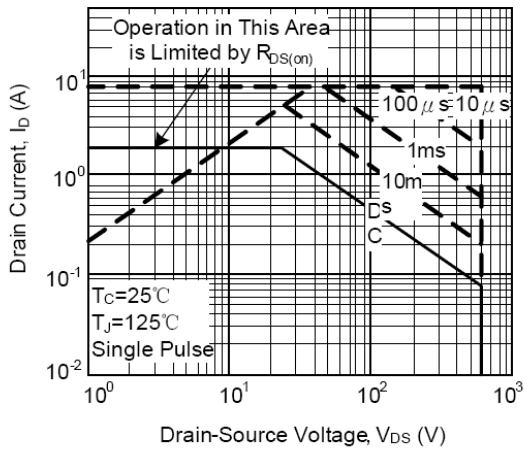

Max. Drain Current vs. Case Temperature

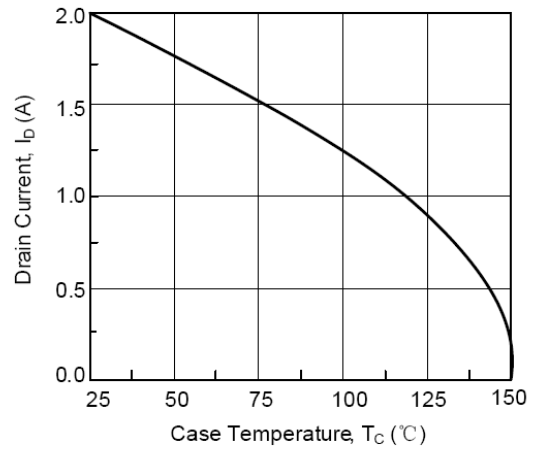

Thermal Response

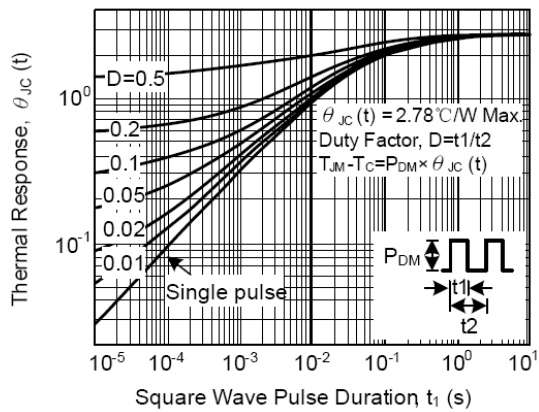

2 Amps, 600 Volts N-CHANNEL MOSFET

2N60

PACKAGE OUTLINE

Plastic surface mounted package

TO-251

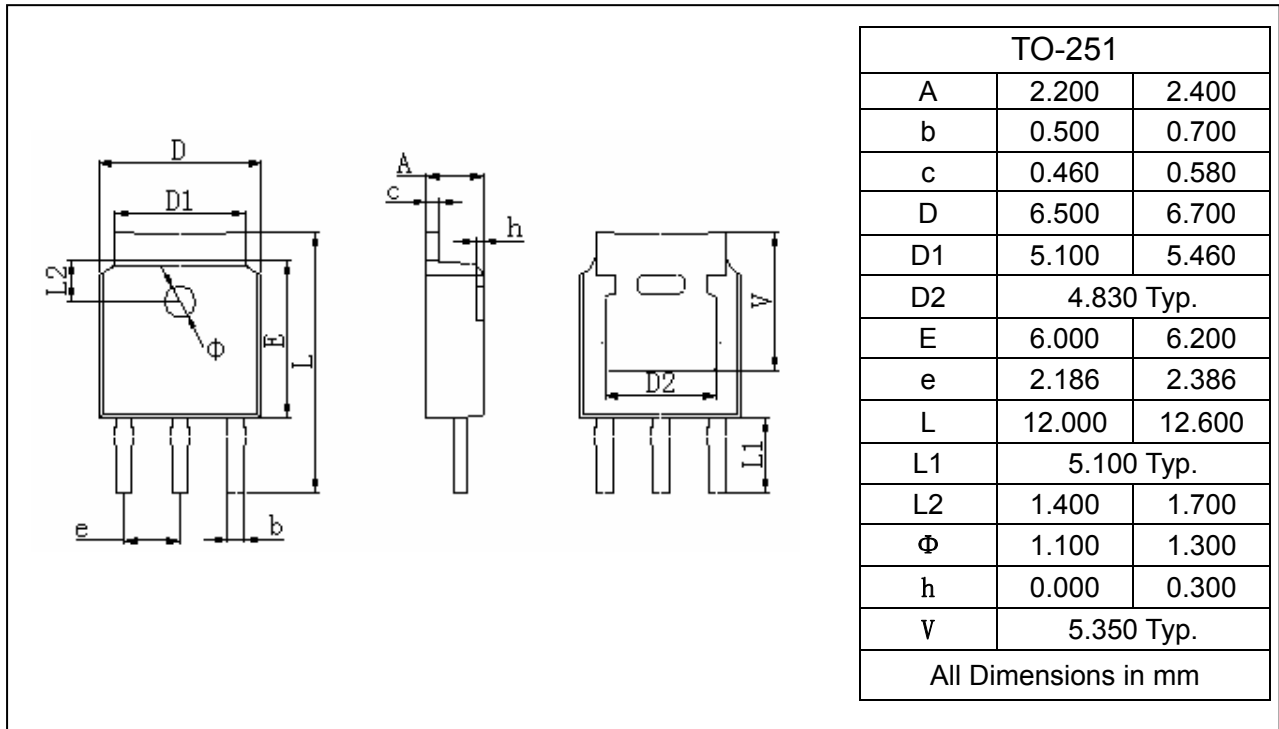

PACKAGE OUTLINE

Plastic surface mounted package

TO-252

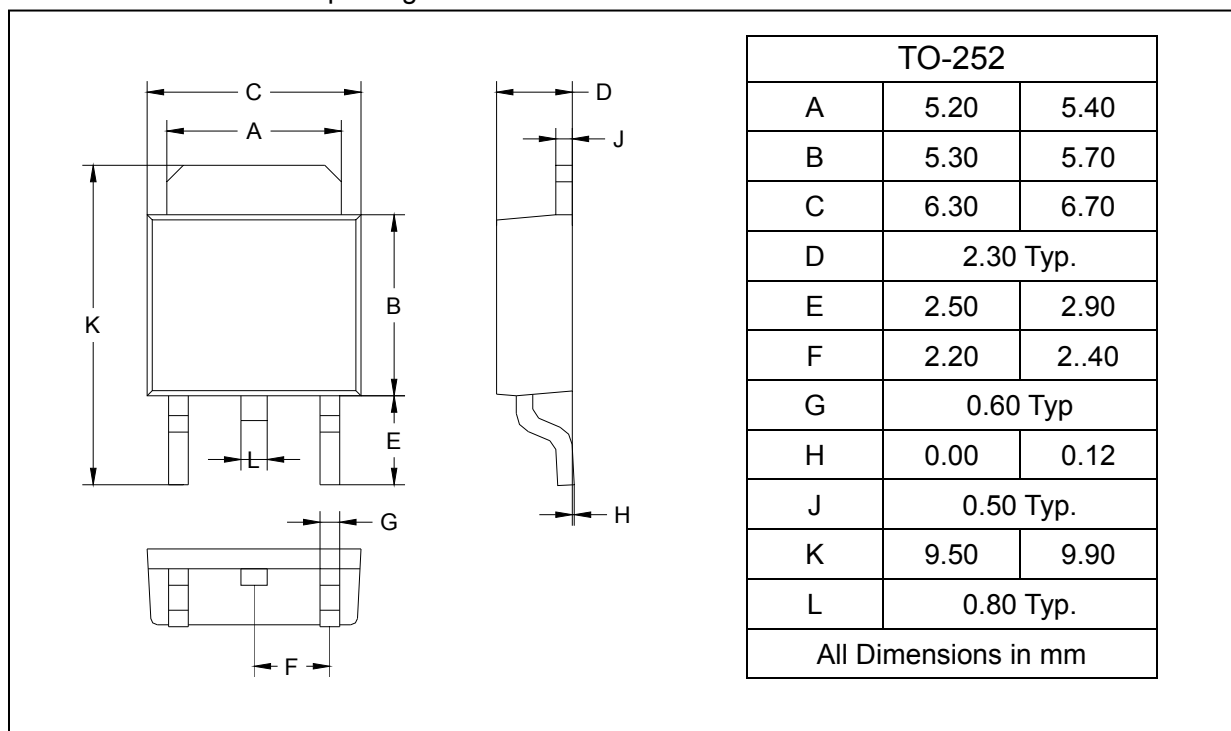



2 Amps, 600 Volts N-CHANNEL MOSFET

2N60

SOLDERING FOOTPRINT

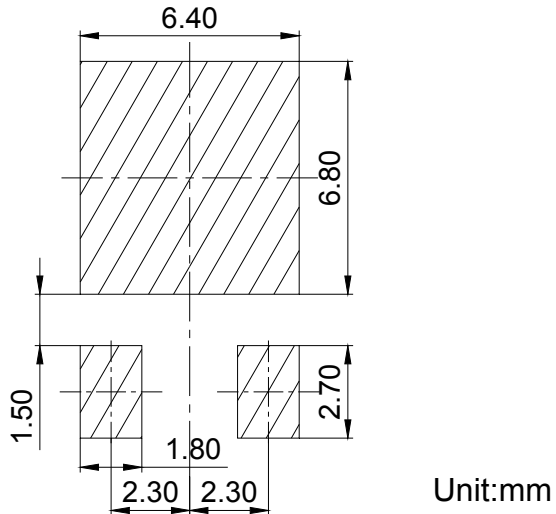

PACKAGE INFORMATION

Device	Package	Shipping
2N60	TO-251/252	80PCS/Tube
	TO-252	2500PCS/Tape&Reel